

T13 LED
Lighting Series

ENGLISH

Installation Manual



Table of contents

1. Product description	3
2. Safety Warnings	4
2.1 Proper use	4
2.2 Product safety	4
2.3 Risk levels	6
3. Available versions	7
4. Guide to installation	8
4.1 Product sizes	8
4.2 Mounting accessories.....	8
4.3 Installation	9
5. Plug-in	11
6. Adjustment light beam	11
7. Troubleshooting	11
8. Light source replacement	11
9. Product maintenance and cleaning	12
10. Repairs	12
11. Warranty	12
12. Product Disposal	13
13. Technical data... ..	14
14. Meaning of symbol keys	14
15. Declaration of conformity.....	15

1. Product Description



LED lamp with adjustable light beam. Ideal for precision lighting. LED light source and flexible arm that allow you to direct the light where desired.

Switch on the base of the lamp. Particularly suitable for lighting on sewing machines, button fasteners, eyelet machines, key duplicators.

- Anodized aluminum spot lamp
- High efficiency LED technology – free maintenance
- Adjustable light beam
- 5000 K light color
- Power supply 100/240 VAC (internal driver LED)
- Flex arm version
- Dimmable version available

2. Safety instructions

T13 LED Lighting Series has been designed and manufactured on the basis of state-of-the-art techniques.

It is made of well-selected, high-quality materials. It is carefully tested throughout the production process, from the raw material through to packaging, following a detailed production schedule so as to guarantee that the product is safe and reliable.

Material damages, as well as bodily injuries, may nevertheless still occur while using it.



- This manual is part of the equipment and must always be kept with it.
- Please make sure that ALL instructions/information in this manual are carefully read through
- Strict compliance with the instructions provided in this manual and on the lighting, equipment is required for its correct use
- Installation and use of the product is recommended only provided it is in perfect conditions, and the

user is well-acquainted with all safety instructions

- CCEA, the manufacturer, waives any responsibility in case of product tampering or improper use

2.1 Proper use of product

This lighting equipment not is fit for being installed inside machine in a wet environment.

2.2 Product Safety

Electrical Risks

The improper and incorrect use of the equipment may cause body injuries and material damages.

- All electrical connection procedures must be carried out by a licensed electrician
- Switch off power supply before any installation, maintenance or reparation procedures.
- Please ensure that the power supply rated tension and frequency meets the requirements shown on the product label. Please respect cable polarity.
- Maintenance and reparations must only be carried out by qualified electricians.

Risk of explosion

The risk of the explosion might occur upon installing and using this product for applications with a

high risk of explosion. It might cause severe body injuries.

- **Do not** install and use this product in hazardous environments (high risk of explosion).

Installation and safety

- Handle the lamp with care and avoid having it drop or being hit even it is still packed, which might cause body injuries, as well as material damages.
- Ensure the original fixing accessories are used, as available from the manufacturer.
- Set up the fixing accessories properly.
- The equipment must be correctly fastened using the proper screws according to the application, place and surface where the product is being mounted.
- Ensure that the fastenings are regularly checked.

Danger of dazzling glare due to a white light source

Avoid staring directly at the light source, as it may cause a temporary reduction of vision. Irritation, aches, damages, or accidents may as well occur.

- Avoid staring directly at the light source.
- The device must be adjusted so as to avoid having the light

flow directed towards the eyes.

Danger caused by inappropriate spare parts.

Using inappropriate spare parts may cause bodily injuries and material damages.

- **Do not** use spare parts that have not been approved by the manufacturer.

Damage caused by presence of laser beams

Use of the T13 LED lighting equipment **is not** allowed when a high-power laser is operating, since it may damage the Led source.

Danger due to high temperatures

Installing and using the equipment in all the environments where the existing temperature remarkably exceeds the foreseen operating temperature will considerably reduce Led lifetime while damaging as well the built-in electronic components.

- **Do not** use this Device in environments where the operating temperature of the device is exceeded.
- Operating temperature - 4°/113°F (-20 / +45 °C)
- Avoid direct solar radiation.

Danger due to repairs

Having the product disassembled or repaired without any appropriate technical /electrical

knowledge may cause damages to persons and objects.

- **Do not** try to repair or disassemble the equipment. Please apply to qualified technicians for any issues.
- Any product tampering or modifications not having been approved by the manufacturer will null and void the warranty.

2.3 Damage risk levels



DANGER

Dangers where noncompliance may **immediately** severe injuries and eventually lead to death.



WARNING

Dangers where failure to satisfy requirements **may** lead to severe injuries or even to death.



ATTENTION

Dangers where failure to satisfy requirements **may** lead to injuries.

NOTICE

Dangers where failure to satisfy requirements **may** cause damages to objects.

3. Available versions

Please refer to the table hereunder listing all the lighting equipment, for you to identify the model you need and its main features, for you to have the lighting equipment correctly and efficiently installed and used.

Note: The product code is found on the brand name label stuck on the product's backside.

- Find out the product code printed on the brand name label and see if you find it on the table hereunder;
- Compare the codes and see if you can identify the same model on the table hereunder;
- The code printed on the brand name label shows the device's week and year of production.

T13							
Model	Optics	Power	Power Usage	E Connection	Weight	Color lamp	Driver LED
T10122S01	adjustable	3 W	100-240 Vac	CABLE + EUROPLUG	2.54 lb (1.15 kg)	RAL 7035	internal
T10122S02	adjustable	3 W	100-240 Vac	CABLE + EUROPLUG	2.54 lb (1.15 kg)	BLACK	internal
T10122S03	adjustable	3 W DIM	100-240 Vac	CABLE + EUROPLUG	2.65 lb (1.20 kg)	RAL 7035	internal
T10122S04	adjustable	3 W DIM	100-240 Vac	CABLE + EUROPLUG	2.65 lb (1.20 kg)	BLACK	internal

4. Guide to installation

4.1 Product sizes

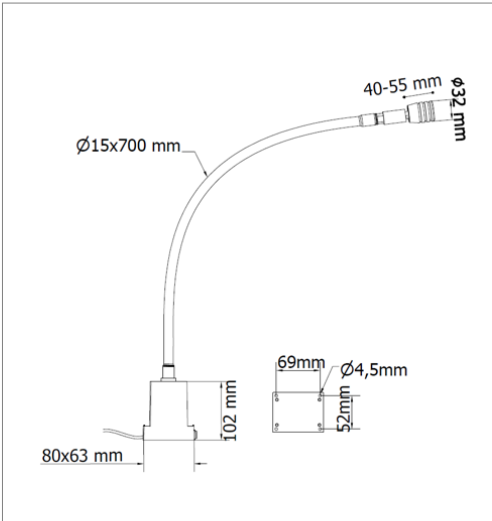

4.2 Mounting accessories

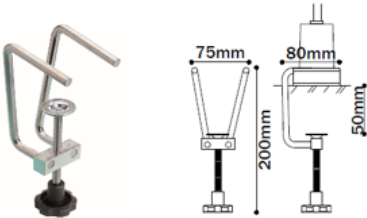

cod. **CLAMP03**

Robust, versatile vibration-resistant metal clamp made of stainless steel.

4.3 Installation



ATTENTION

The lamp fall-down may cause damage to persons and objects

- When mounting the lamp ensure that the original fastenings are used, which you may purchase from the supplier.
- Have the fastening accessories correctly mounted.
- **Version with flex arm: do not bend the flexible tube and avoid small bending radii.**

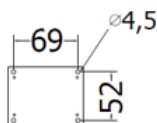

Fixing center distances

Installation T13 LED with metal clamp CLAMP03

Hook the clamp to the lamp by placing the two levers on the sides of the base. Then fix the lamp to the table.



WARNING

Switch off the power supply before proceeding to installation.

Correct installation T13 LED using screws

The lamp base has 4 fixing holes for screws. Provide the fixing holes on the dedicated surface following the indications of the fixing distances shown in the figure. Use screws of adequate size and material depending on the application.



NOTICE

Damaged or broken lamp.

- When mounting the lamp ensure to never completely loosen the screws in order to avoid the lamp fall- down.

NOTE: The fastening parts for this lamp are available as accessories. Please For further details, visit our website:

www.ccealights.com

NOTICE

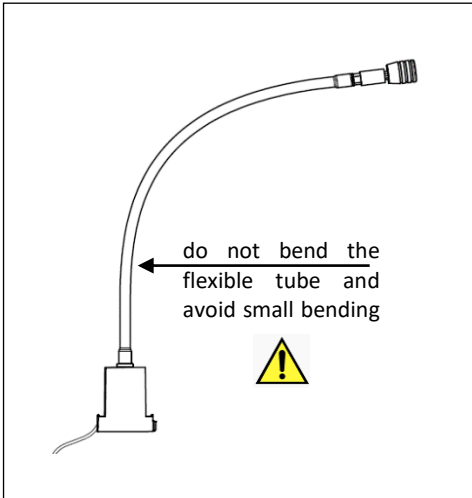

5. Plug-in



WARNING

Wrong wiring may cause damages to the lamp

- All electrical connections have to be carried out by qualified electricians.
- Always use the power cord supplied with the lamp.
- Ensure that the supply voltage range to the lamp is closely respected in order to avoid damaging the Led drivers.

The lamp is supplied with a EURO 2x10A plug cable. Connect the lamp directly to the mains voltage.



The lamp is equipped with one on/off switches:

The switch on the base interrupts the power input of internal LED driver.

Dimmable version

In the dimmable version, the dimmer adjustment is placed on the lamp base

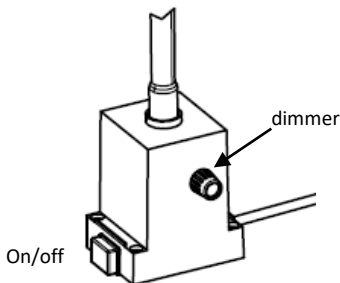

6. Adjustment of the light beam

By sliding the outer part of the spot it is possible to adjust the light beam



7. Troubleshooting

In case the lamp doesn't turn on:

- Check that the lamp is properly wired to the supply voltage.
- Check that polarity wiring has been carried out correctly.

Please contact CCEA'S USA Technical support service in case the lamp is defective

CCEA Technical Support Service
Phone: +39 0444 572083
ccea@ccealights.com
www.ccealights.com

8. Replacing the Led light source

The outstanding lifetime of the LED light source, over 60.000 hours, makes it unnecessary to replace the PCB LED if the lamp is properly installed and used following the instructions in this manual. Please contact CCEA'S Technical Support service - or your Reseller – in case the replacement of the PCB LED is needed for any defects not covered by the warranty.

9. Product maintenance and cleaning



WARNING

Switch off the power supply before any installation, maintenance, or reparation procedures.

This product is maintenance-free.

- Lamp cleaning is to be carried out only after it has been switched off and surfaces have cooled.
- Carefully rinse the lamp surface with a mild cleanser and then wipe off using a soft cloth in order to avoid scoring

NOTICE

All material damages caused by liquid leakage may damage the lamp.

10. Repairs

NOTICE

All material damages caused by poorly executed repairs may damage the lamp

- All repairs must be carried out by the manufacturer or by qualified technicians.
- Only use spare parts having been approved by the manufacturer.

11. Warranty

Terms of warranty

CCEA ensures that any control procedures or repairs – to be carried out exclusively at/by CCEA Technical service dept. or by any CCEA'S official dealer – are covered throughout the entire product's lifetime. In view of the above, take care to preserve the product label and case, to be submitted if any repair operations are needed.

All repair and spare parts costs will be notified after the defects have been examining.

The warranty does not cover:

- Any transport, packaging, or shipping costs;
- Any damages or deterioration caused by:
 - Installation and/or operation carried out following different ways;

- Any unauthorized repairs or attempts to repair the product;
- Equipment operation under environmental conditions other than those indicated in the user manual;
- Liquid leakages inside the lamp;
- Failure to follow the safety precautions related to transport and to shipping the product back for repair (please make sure to have it shipped back in its original case).

to know where the collection facilities are located.

Period of warranty

The warranty period covers 24 months, starting from delivery date. CCEA guarantees that the products have no manufacturing defects or malfunctioning.

12. Product disposal

All the electrical and electronic equipment (WEEE) have to be managed with a selective waste sorting and cannot be disposed of as municipal waste, as provided for in Directive 2012/19/UE.

In view of the above this equipment, all its components, subsystems and the consumables which are an integral part of the product have to be conveyed to the local collection facilities for them to be disposed of in accordance with the current legislation.

Please apply to the council offices of your place of residence in order



13. Technical data

NOTE: Please refer to the data printed on the label stuck on the lamp.

Power supply	100-240 Vac 50/60 Hz
Power input	3 W
Light color temperature	5000 K
CRI	80
Operating temperature	-4 F° / 113° F (-20 / +45°C)

For any further information please refer to the table at page 7

14. Symbol keys

	CE Conformity marking
	Protection class II device
IP40	Degree of protection IP40

15. Declaration of Conformity

C.C.E.A. SRL, via Piave, 2 - 36077 Altavilla Vicentina (VI), Italy – VAT and Tax number 02374040240 hereby declares that the light equipment named T13 LED series – to which the present Declaration of Conformity is related - was manufactured by CCEA SRL in accordance with the following Directives: 2014/35/UE on Low Voltage Equipment Safety and the Directive of Electromagnetic Compatibility 89/336/CEE (EMC) 2014/30/UE. The unit complies in particular with the following regulations:

- **Directives:**



Machinery Directive 2006/42/EC
Low Voltage Directive 2014/35/EU
EMC Directive 2014/30/EU

- **Harmonized Standards**

- CEI EN 60598-1 “Lighting equipment. Part 1: General instructions and tests”
- CEI EN 60598-2-4 “Lighting equipment part 2: particular requirements – part 4 Portable general-purpose luminaries”.
- CEI EN 62031 “LED modules for general lighting. Safety specifications”.

This is a standard product manufactured following a detailed production schedule ensuring that inspections and destructive tests were carried out, for a safe, functional and sustainable product to be delivered.

C.C.E.A. SRL disclaims any responsibility resulting from tampering and/or wrong use of the device.

Date: _____

Week of production: _____

Product code: _____

C . C . E . A . s r l
 Via Piave, 2
 36077 Altavilla Vicentina (VI) - Italy
 Tel. ++39 0444 572083
 Fax. ++39 0444 572337
 E-mail: ccea@ccealights.com
 www.ccealights.com